

MFB Series 2 - Brass

Expansion joint cover system



Innovative solutions for Pedestrian Traffic

The MFB Series 2 expansion joint system is designed for minimum rebate installations with a block out required of only 16 H x 13 W mm.

Examples of applications such are:

- Shopping & retail centres
- Hospital walkways, corridors, & public buildings
- Indoor and outdoor public spaces



Features

- Foot safe for Pedestrian Traffic
- Minimum Rebate Required
- Surface Fixed
- Suited well to Retrofit outs
- Standard Length = 3.6 meters

Benefits

- Low maintenance though design simplicity
- Structural grade ensures extended serviceability
- Base system incorporates anchoring points
- Can be installed to suit all floor finish types including tile carpet, stone, vinyl, concrete and epoxy floors.

Other Options

- Stainless Steel and Aluminum options
- Water and Fire barrier
- Recommended Bedding Materials:
 - Pedestrian traffic: Ramset Premier Grout
 - Vehicle traffic: Miska FC122 Epoxy Mortar

Additional Services

Loading
Miska provides loading calculations based on specific project requirements.

Installation
Installation instructions provided on request, Miska can also provide contacts for approved installers in your area.
Please contact your representative for details.



PEDESTRIAN

SERVICES EQUIP



HORIZONTAL



FIXINGS SUPPLIED



OUTDOOR



INDOOR

Options Available:

FIRE RATED

WATERPROOF

STAINLESS STEEL

ALUMINIUM

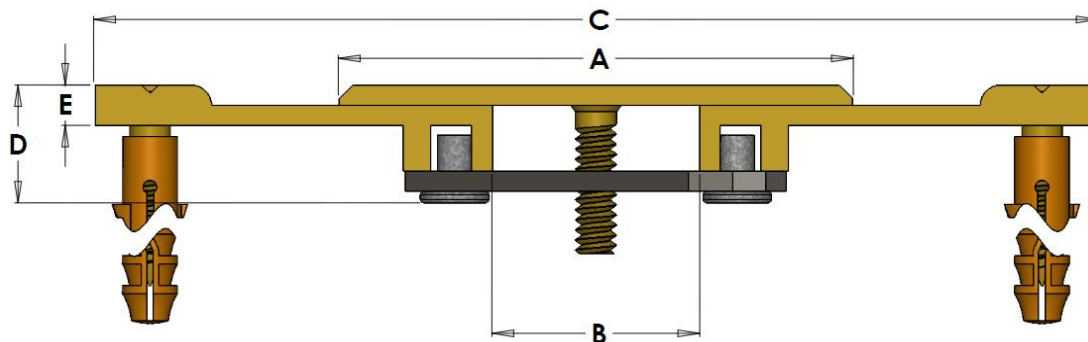

Block out Dimensions 16 H x 13 W		Physical Data								All measurements stated are in mm.	
Code	A = Coverplate		B = Gap				C = Exposed Width			D	E
	Width	Thick	Min	Mid	Max	Mvmt	Min	Mid	Max	Height	
MFB75S2	75	3	7	30	53	46	123	146	169	17.5	6
MFB100S2	100	3	18	48	78	60	134	164	194	17.5	6

Disclaimer: The information contained in this publication is intended to give a fair description of the products and their capabilities. No responsibility or liability by the manufacturers will be accepted for misuse, misreading or deviation from the recommended guidelines of these products. As new technology is introduced, or industry standards are altered, Miska reserves the right to alter the information without notice.

Rev.02
Feb 2011

Miska (Aust) P/L
(A business unit of ITW Australia)
P.O. Box 1021 Archerfield, Queensland, 4110.
Telephone: 61 7 3277 7077 Facsimile: 61 7 3277 8858
Web: www.miska.com.au